

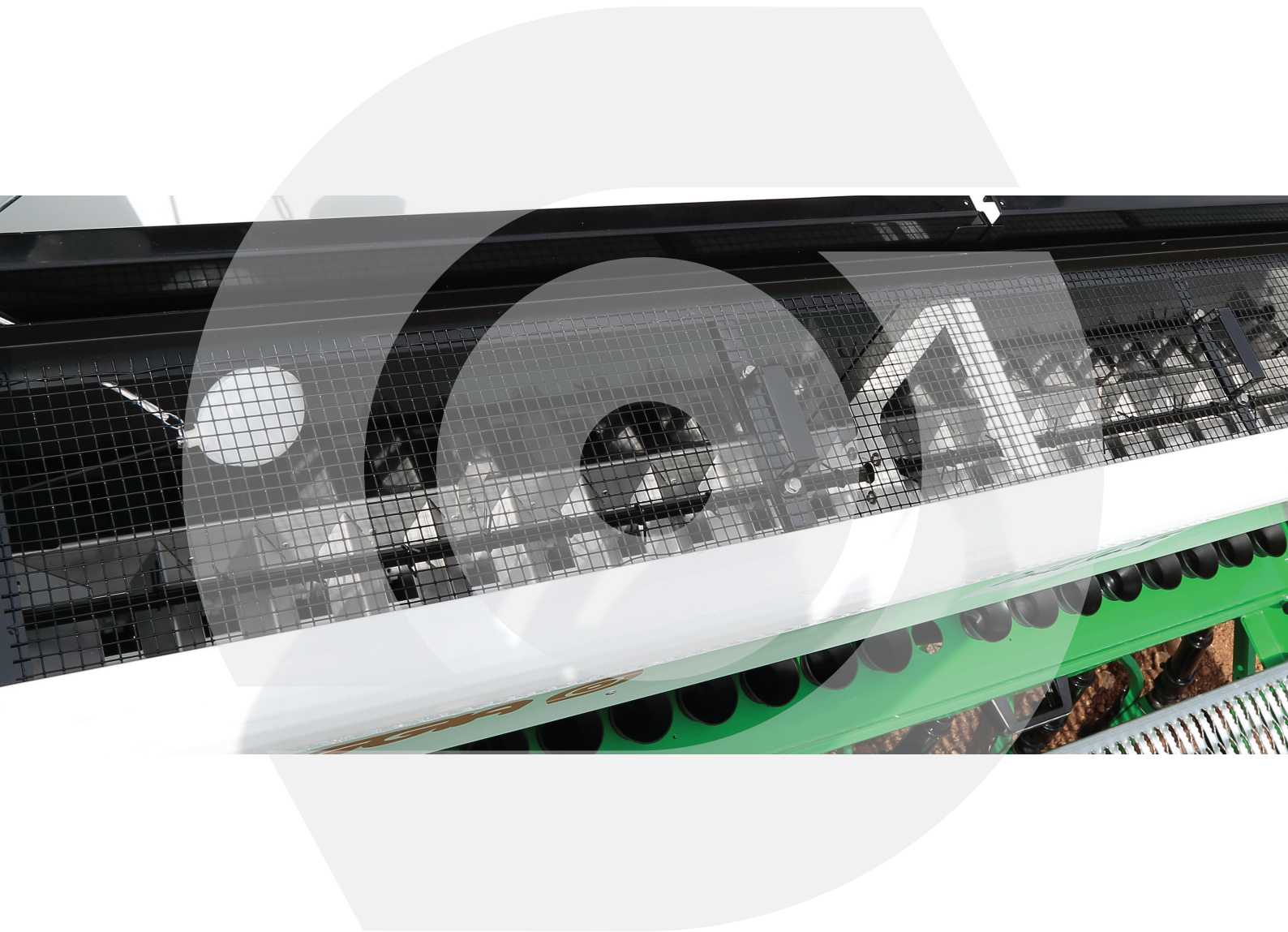

SFOGGIA 
AGRICULTURE DIVISION

Drill Sem



Mechanical Seed Drill
for cereals and all small seeds



SFOGGIA 
AGRICULTURE DIVISION

Drill Sem



> Precise, robust, of design

DRILL SEM is now more powerful than ever.

It offers a range of configurations and accessories that satisfy the most demanding farmer in the different types of soil.

Simple in its design, robust in its construction, reliable in seeding and precise in the distribution of fertilizer and insecticide.

Drill Sem is the machine that adapts to multiple needs of use. It is available in a mounted and pulled version, in seed only version, seed plus fertilizer, seed plus fertilizer plus insecticide.



Drill Sem





> Versatile in configuration, easy to adjust

A wide range of versions and configurations is combined with quality accessories to satisfy different crops, inter-rows and soils.

Drill Sem has a large seed hopper in painted steel with double plastic distribution rollers for the distribution of small and large seeds. The new sowing boxes are in steel painted in cataphoresis (version S) and in stainless steel (version SF), they can be opened and inspected through a door.

On request the seed hopper can be divided into two and also used for a second crop or for the distribution of the fertilizer. Each hopper has a gear box in oil bath with three cams. The possible configurations are:

- straight / curved coulters arranged in three rows;
- double offset disc coulters arranged in two rows;
- single disc furrowers arranged in two rows.

All the coulters have telescopic tubes for the descent of the PVC seed.



> Fleet on the field

Drill Sem

DRILL SEM S
seeds

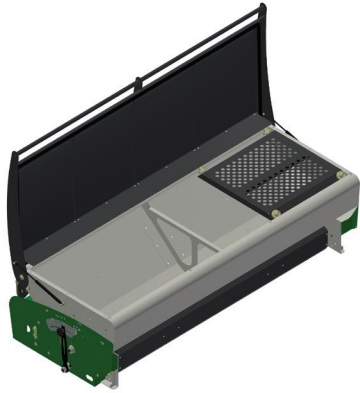

DRILL SEM SF
seeds + fertiliser

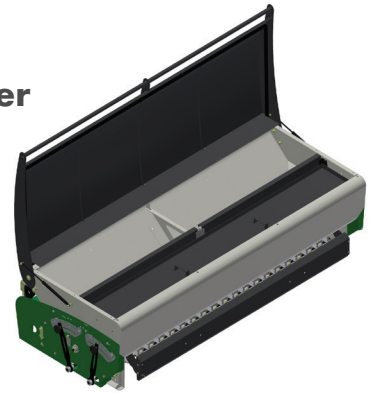

DRILL SEM DSA-S
With straight/curved head coupler



DRILL SEM DSA-SF
With straight/ curved head coupler



DRILL SEM DSD-S
With single disc



DRILL SEM DSD-SF
With a single disc



DRILL SEM DSDD-S
With a double disc

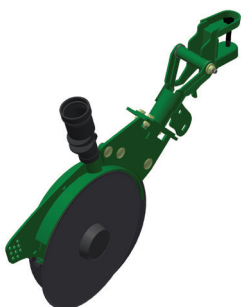

DRILL SEM DSDD-SF
With a double disc

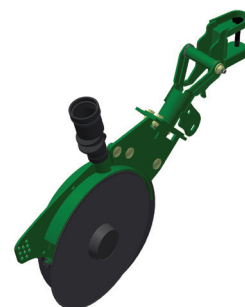





> The versions

■ MOUNTED

With Three point hitch of II cat.

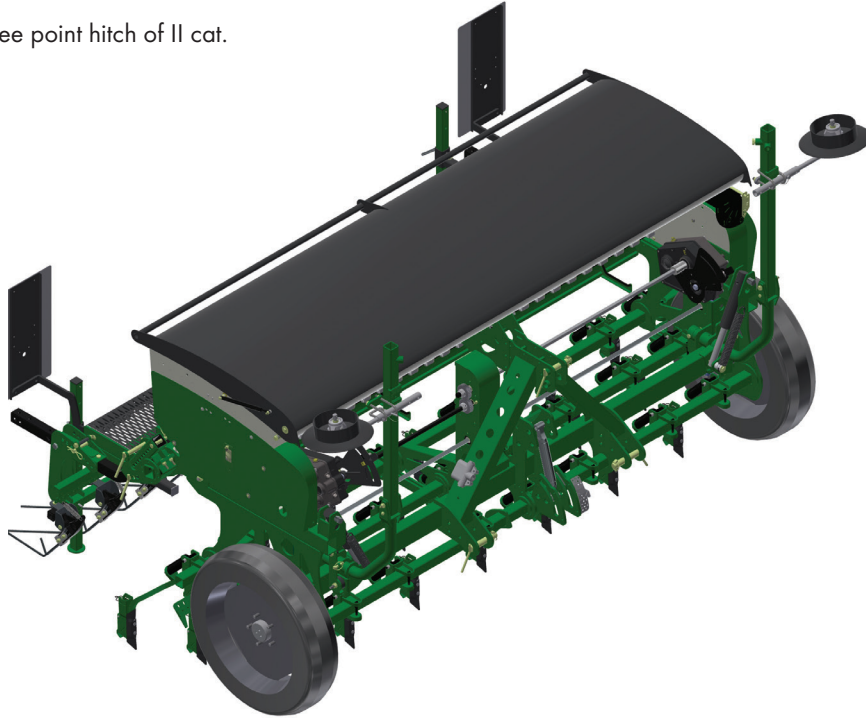

■ PULLED

Suitable for use on soil with steep slopes with tracked tractors. Possibility to easily transform it into a extended version.

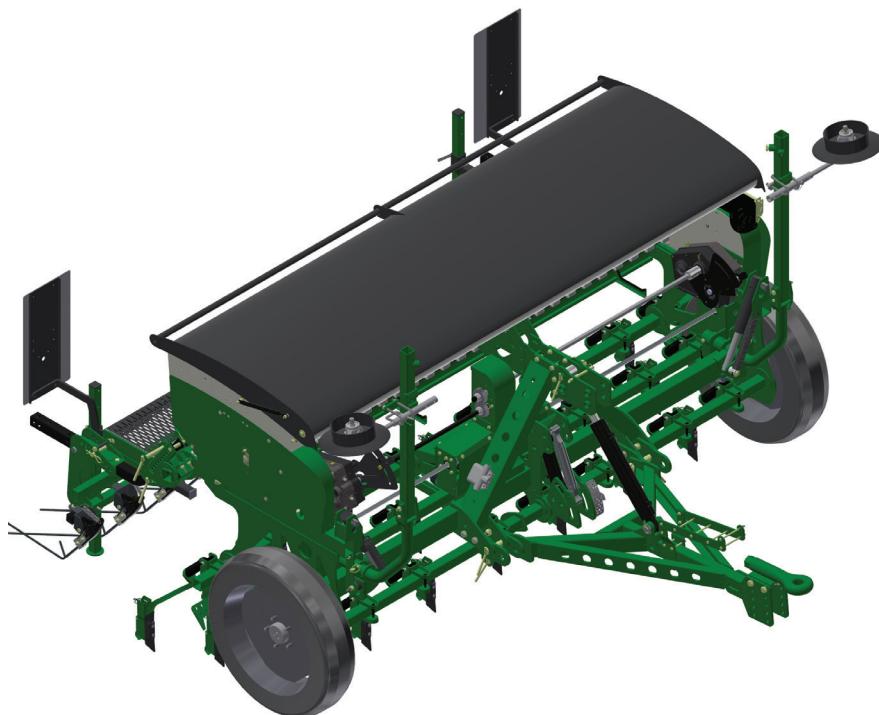



SFOGGIA

SFOGGIA

SFOGGIA



MAX



> Hoppers



Drill Sem S has a unique hopper with double plastic seed distribution rollers, cam variator and seed indicator float. The seed hopper is equipped with a trolley to carry bags to help load the hopper.

In the Drill Sem SF model the hopper is divided into two by a removable sluice gate, the part used for the fertilizer is equipped with a metal grid to sift the fertilizer.

Both parts have double plastic distribution rollers in stainless steel boxes and independent cam gear box.

The double hopper can be used for the distribution of two different types of seeds.

A "hill kit" is available on request.

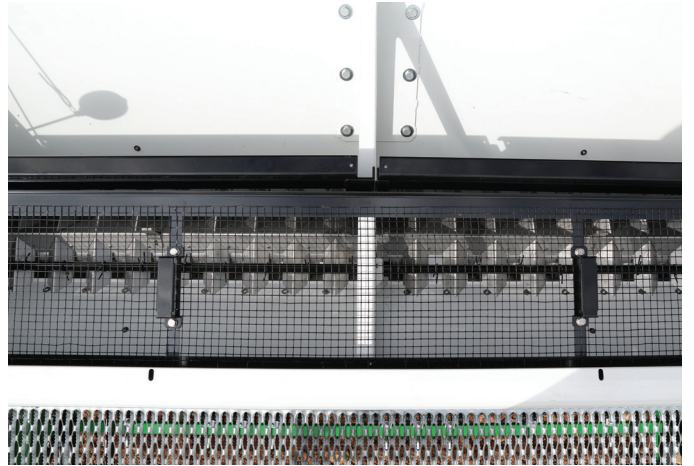

The third hopper is suitable for the distribution of small seeds or insecticide.

The adjustment is independent of the rest of the machine and a cam gear box guarantees high precision even for small quantities.





D
D
D
D
D
D
D
D



Drill Sem

SA
SD
SDD
SA
SD
SDD
S
SS
SSS
S
SF
SF
SF

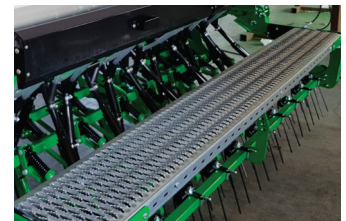
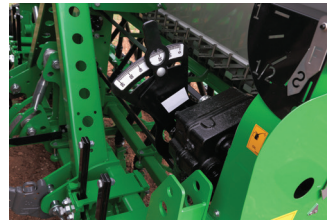
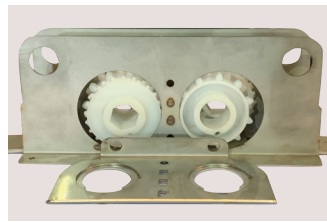

> Options on request



(A) Double harrow with parallelogram, with platform and loading ladder



The seed covering harrow is fundamental to guarantee the quality of sowing.

For this reason Sfoggia offers the possibility to choose between two versions of harrows:

- double harrow with parallelogram: follows the morphology of the terrain, 95 kg (A);
- self-leveling single harrow: it allows a wide range of values for adjusting the inclination and working pressure, 145 kg (B).

The straight or dovetail springs are interchangeable in the version A harrow.

The self-leveling springs are available only in the harrow version B.



(B) Self-leveling harrow with platform and loading ladder

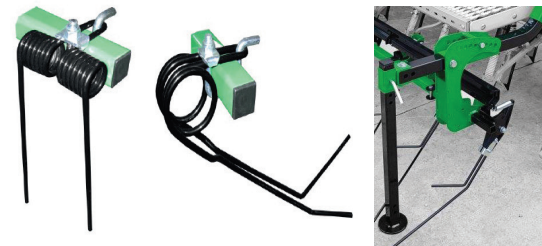
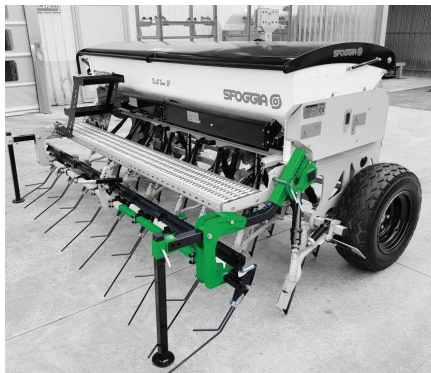

Straight Spring - A

Spring Swallowtail - A

Spring Self-leveling - B



Third hopper



On request, the rubber seed descent tube enters the seed fall tube



Wheel for single disc for seeding depth adjustment



Small wheel coupled with single disc



Seed cover wheel for double disc for seeding depth adjustment

Drill Sem



Hydraulic row marker



Manual Row marker

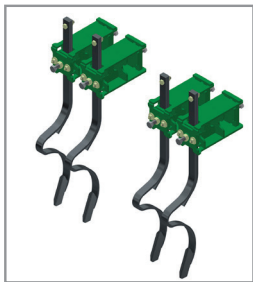

Light Tracks Remover
4 tines



Tracks Remover
2 heavy tines



Couple of big wheels
10.0/75 for models 2,5 - 3 m

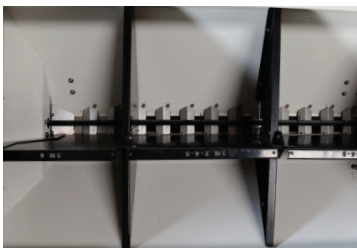

"Hill" Kit



Kit tramline



Monitor Sowing Control



Electronic Count-hectar



Double drive wheels



Manual system
and seeding depth
adjustment



Hydraulic furrow lifting
system for trailed
machine

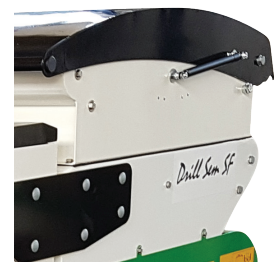

Hopper support 200 L,
only on 3 m version



SFOGGIA 

Drill Sem 5



Drill Sem



Models	n. rows	Row distance cm	Working Width m	Transport Width m	Capacity L		
					Version S	Version SF	
					Only Seed	Seed	Fertiliser
DSA S (SF) 2500-17	17	15,0	2,55	2,55	500	270	240
DSA S (SF) 2500-18	18	14,2	2,55	2,55	500	270	240
DSA S (SF) 2500-19	19	13,4	2,55	2,55	500	270	240
DSA S (SF) 2500-20	20	12,8	2,55	2,55	500	270	240
DSA S (SF) 3000-21	21	14,3	3,00	3,00	610	330	290
DSA S (SF) 3000-22	22	13,6	3,00	3,00	610	330	290
DSA S (SF) 3000-23	23	13,0	3,00	3,00	610	330	290
DSA S (SF) 3000-24	24	12,5	3,00	3,00	610	330	290
DSA S (SF) 3000-25	25	12,0	3,00	3,00	610	330	290
DSA S (SF) 3500-27	27	13	3,50	3,70	700	390	350
DSA S (SF) 3500-28	28	12,5	3,50	3,70	700	390	350
DSA S (SF) 3500-29	29	12	3,50	3,70	700	390	350
DSA S (SF) 4000-31	31	13	4,00	4,20	820	460	410
DSA S (SF) 4000-32	32	12,5	4,00	4,20	820	460	410
DSA S (SF) 4000-33	33	12	4,00	4,20	820	460	410

DSD - DSDD S (SF) 2500-17	17	15,2	2,55	2,55	500	270	240
DSD - DSDD S (SF) 2500-19	19	13,5	2,55	2,55	500	270	240
DSD - DSDD S (SF) 3000-21	21	14,4	3,00	3,00	610	330	290
DSD - DSDD S (SF) 3000-23	23	13,1	3,00	3,00	610	330	290
DSD - DSDD S (SF) 3000-25	25	12,0	3,00	3,00	610	330	290
DSD - DSDD S (SF) 3500-25	25	14	3,50	3,70	700	390	350
DSD - DSDD S (SF) 3500-27	27	13	3,50	3,70	700	390	350
DSD - DSDD S (SF) 3500-28	28	12,5	3,50	3,70	700	390	350
DSD - DSDD S (SF) 4000-29	29	14	4,00	4,20	820	460	410
DSD - DSDD S (SF) 4000-31	31	13	4,00	4,20	820	460	410
DSD - DSDD S (SF) 4000-33	33	12	4,00	4,20	820	460	410





Via Feltrina Sud, 170
31044 Montebelluna
Treviso - Italy
www.sfoggia.com

T +39 0423 24041-42
T +39 0423 24014
info@sfoggia.com



Drill Sem